

# FUTON ASSEMBLY INSTRUCTIONS

PLEASE READ PRIOR TO ASSEMBLY  
WE RECOMMEND 2 PEOPLE TO ASSEMBLE

## STEP 1 Parts

Check to see if all the parts have been provided.

### Parts List

Wood Parts:	Two (2)	Arm Ends (right and left)
	One (1)	Back Deck
	One (1)	Seat Deck
	Two (2)	Stretcher Rails
	One (1)	Support Block
Hardware:	Five (5)	Long Screws
	Eight (8)	Short Screws
	Four (4)	Stoppers
	Four (4)	2" Clevis Pins (for nylon guides)
	Two (2)	2 1/4" Clevis Pins (for connecting back deck to seat deck)
	Eight (8)	Hex Bolts*
	One (1)	Hex Key (Allen Wrench)
	Six (6)	Hitch Pins
	Four (4)	Nylon Conversion Rollers
	Eight (8)	Barrel Nuts
	Six (6)	Washers

Two (2) Arms (style may vary)

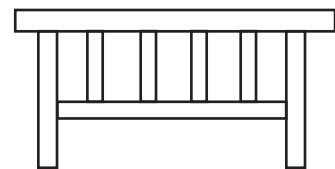

Seat Deck

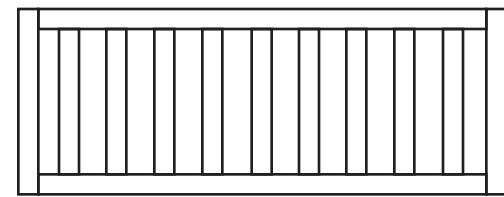

Support Block



Four (4) Nylon Conversion Rollers

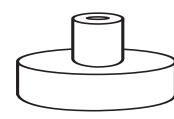

Four (4) 2" Clevis Pins

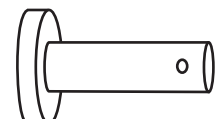

Two (2) 2 1/4" Clevis Pins

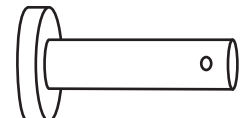

Eight (8) Hex Bolts \*

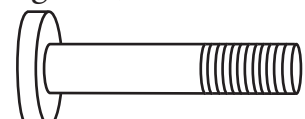

Two (2) Stretcher Rails

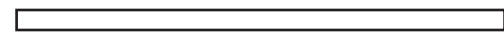

Back Deck

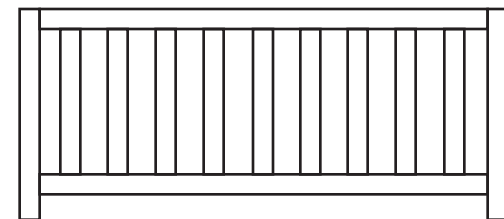

Five (5) Long Screws



Eight (8) Short Screws



Four (4) Stoppers



Eight (8) Barrel Nuts

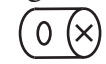

Six (6) Hitch Pins



One (1) Hex Key (Allen Wrench)



Six (6) Washers



## STEP 2

Locate 2 arms and 2 stretchers. Starting at one corner loosely assemble using 2 hex bolts and 2 barrel nuts at each point.

Note: the grooves in the arms faces inside as do the holes in the stretchers. Certain styles have 2 size bolts. The longer bolts should go in the front. Insert the barrel nuts into the holes in stretchers with the groove in the barrel facing you. You can use a screwdriver to align barrel nut with bolts. Do NOT tighten bolts yet.

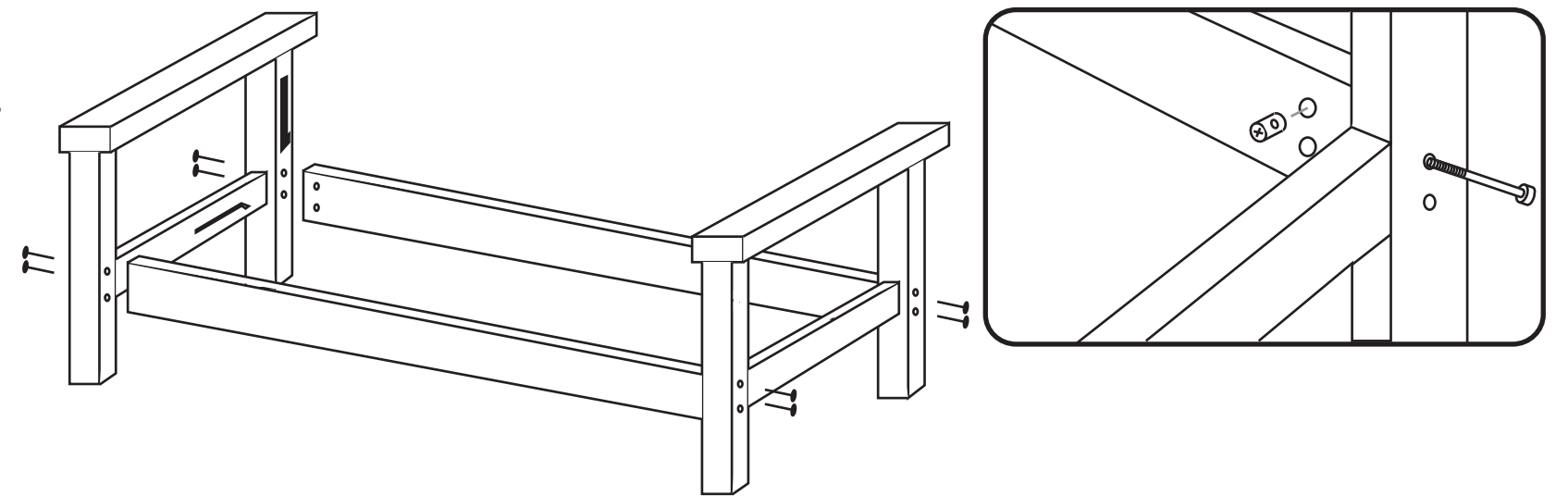

## STEP 3

Attach the back deck to the seat deck using the 2 long Clevis pins, with a washer and cotter pin. Attach 4 nylon conversion rollers to back deck using 2" Clevis pins, washers and hitch pins.

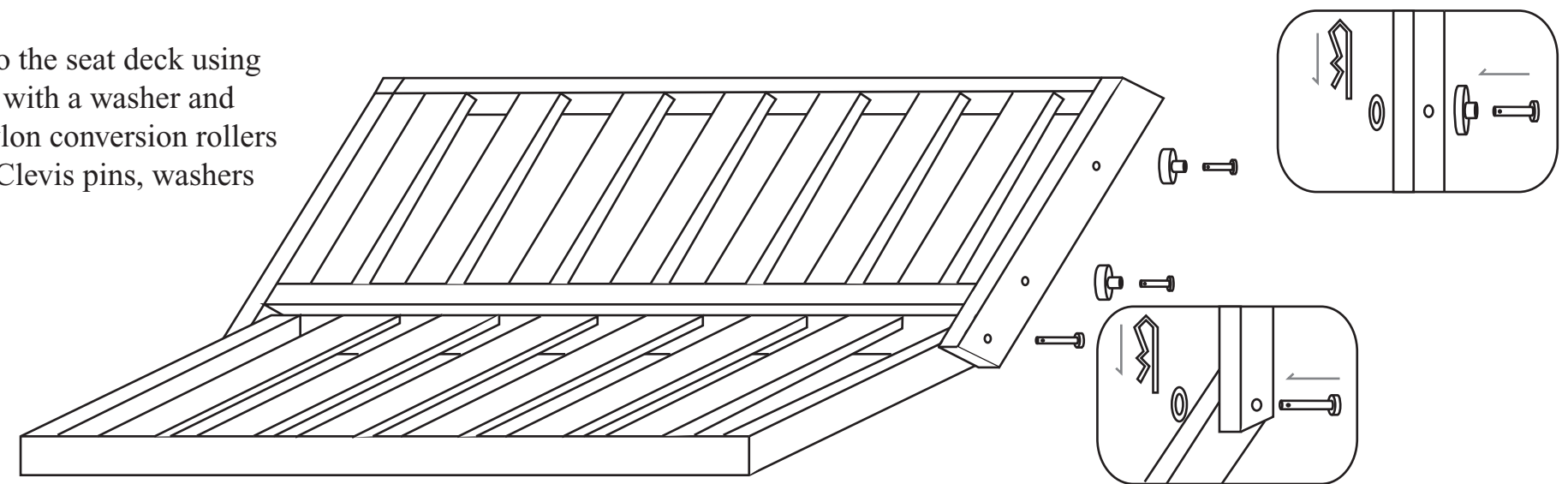

## STEP 4

At this point you have the inner frame assembled and the arms assembled to the stretchers. You are now ready for the final step. Lower the inner frame assembly into the arm assembly taking care to line up the rollers with the grooves in the arms. The top roller fits into the rear groove and the lower roller fits into the forward groove. When they are all lined up you can tighten down the bolts and test to see that the unit operates smoothly.

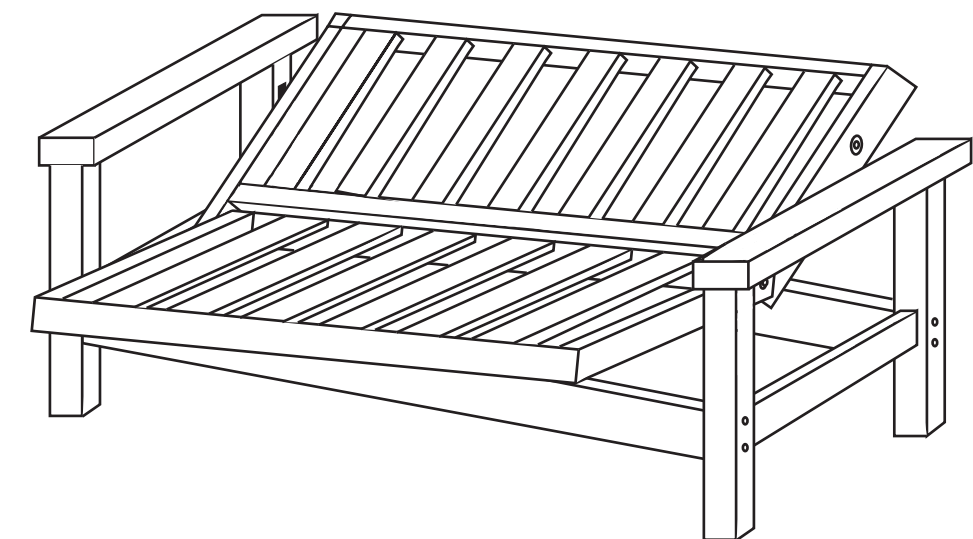

## STEP 5

From the sofa position, mark (with a pencil) the under side of the seat deck where it touches the back corner of the front stretcher rail on both ends of the seat deck. Lay the frame down into the bed position and lift-up the seat deck and fasten the stoppers right behind your mark with the short screws so that the stopper can sit down behind the front rail. An additional pair of stoppers and screws are included for an additional lounge position. Fasten these as before behind the first pair of stoppers. You vary the position to your own desire level of recline. The purpose of these stoppers is to prevent unwanted opening into the bed position which may occur due to the use of heavy futons or inner coil-spring mattresses.



## STEP 6

Continuing from the same position as Step 5, place support block as shown and fasten with 5 long screws. Your frame is now fully assembled. For Queen size frames, 2 support blocks are provided. Fasten these on the 2 centered slats with cross-rails.



COTTAGE FUTONS

By Midwest Imports  
8219 Zionsville Rd.  
Indianapolis, IN 46268  
www.cottagefuton.com

\*Depending on your model, you may get 2 different size bolts. The longer bolts are for the front leg.

## Futon Operation

### To convert From a seat position to a bed:

Allow 12" of clearance between the back deck of the frame and the wall. Grasp the seat deck with both hands, lift up to clear the seat stopper and pull forward. The back deck will drop down to create a sleeping surface. Push the decks back to lock it in.

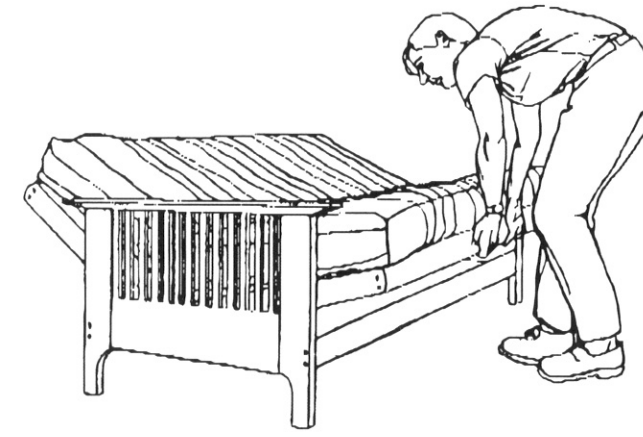

### To convert from a bed position to a sofa:

Pull the decks forward. Then stand at either side of the frame. Grasp the back deck with one hand and place the other hand on the center of the futon mattress. In one continuous motion, pull up on the back deck and push in on the futon mattress until the frame stops in the seating position.

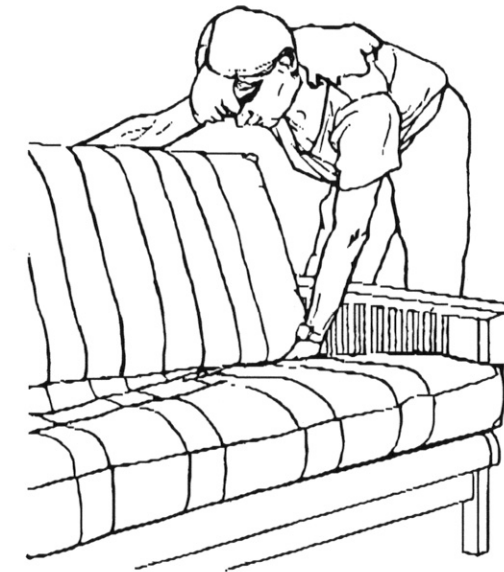

(When using either queen size bi-fold or a high density futon mattress, it is helpful to have two people (one on each side) to operate the frame)

## CARE INSTRUCTIONS

The furniture you have purchased is a natural product and as such requires some care. Periodic waxing / polishing will protect the wood frame from excesses in temperature and humidity changes. As with most ready-to-assemble furniture, the bolts can loosen with use and should be checked periodically and re-tightened with the Allen key provided (please keep it).